



STAYER

LP600BE LP700E

- ES** Manual de instrucciones
- IT** Istruzioni d'uso
- GB** Operating instructions
- FR** Instructions d'emploi
- P** Manual de instruções
- PL** Instrukcja obsługi



STAYER

Área Empresarial Andalucía - Sector I
Calle Sierra de Cazorla n°7
C.P: 28320 Pinto (Madrid) SPAIN
Email: sales@grupostayer.com
Email: info@grupostayer.com

INSTRUCCIONES DE INSTALACIÓN LP 700 E
INSTALLATION INSTRUCTIONS LP 700 E

- 1. Extraer la máquina de la caja.**
Take out the machine from the box.

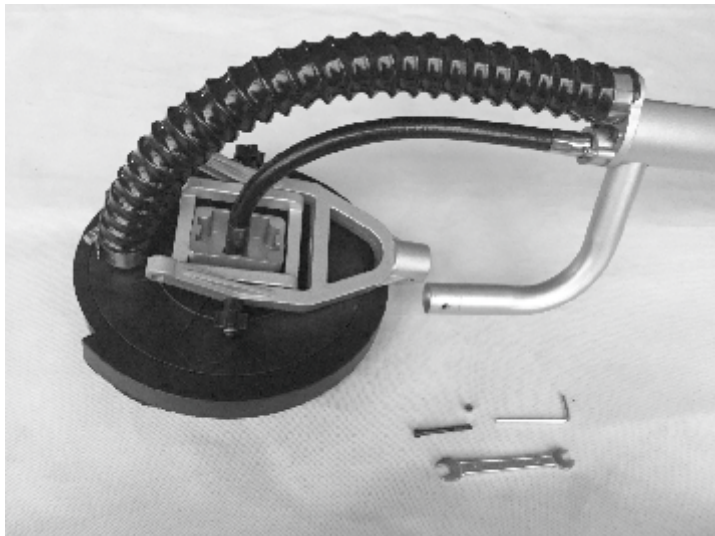

- 2. Insertar el tubo en la articulación.**
To insert the pipe to the front fork.

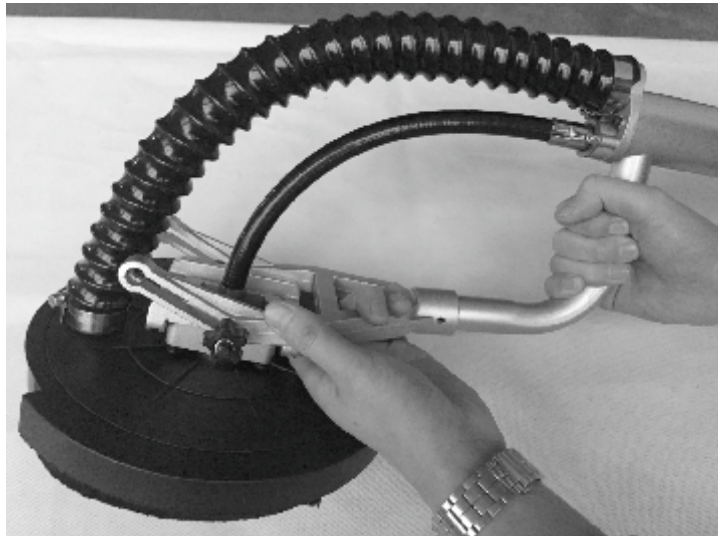

- 3. Alinear agujeros.**
To make sure the 2 parts align to a pile hole.

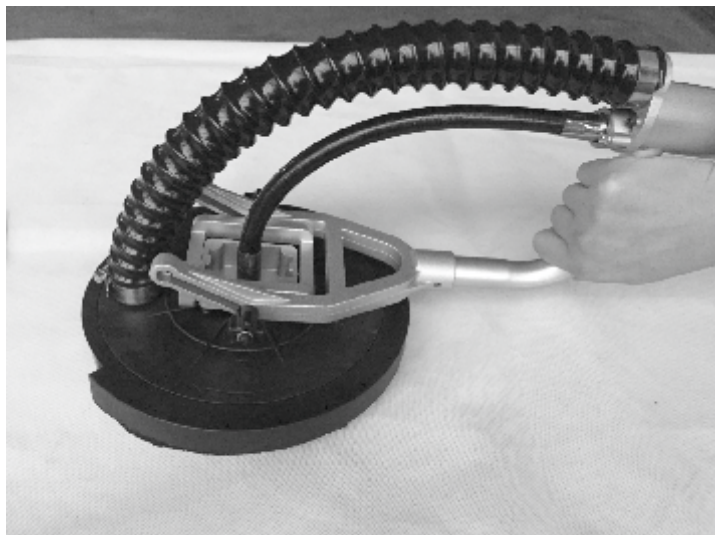

- 4. Instale el tornillo de fijación.**
To put the hexagon socket screw and tighten it.

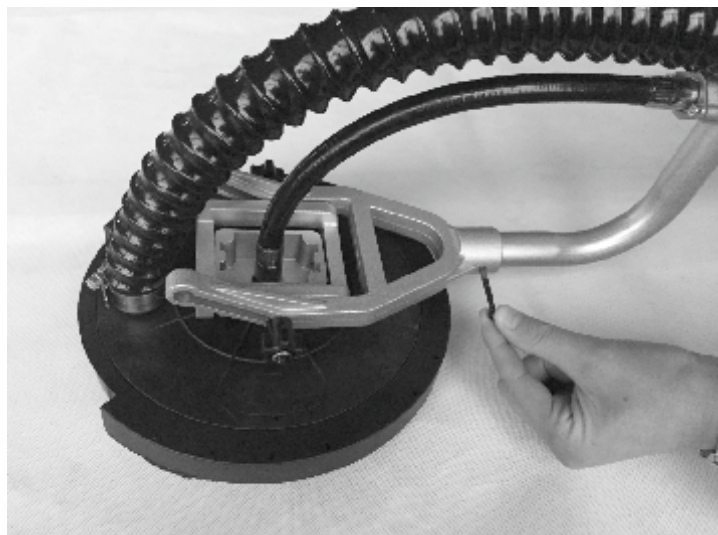

- 5. Terminado.**
Completed.

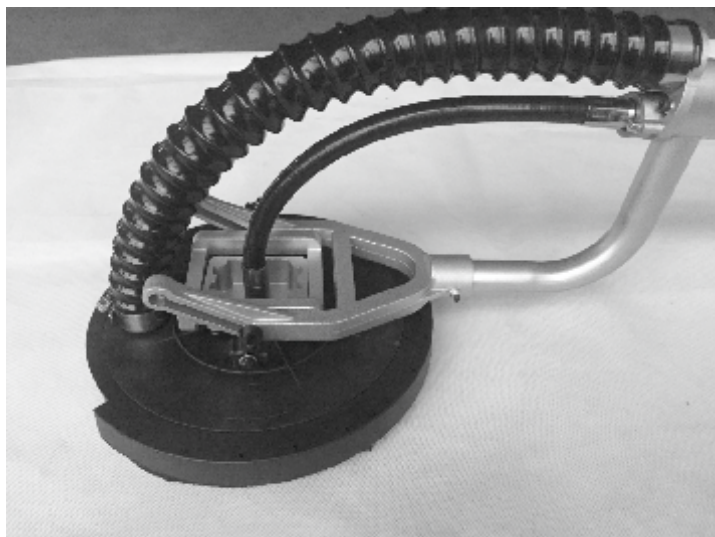

LP600 BE

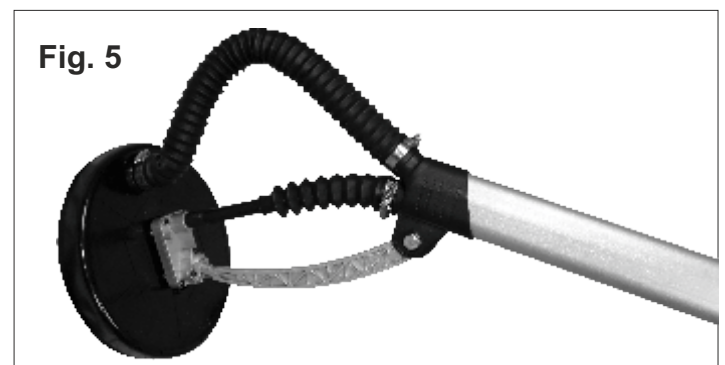
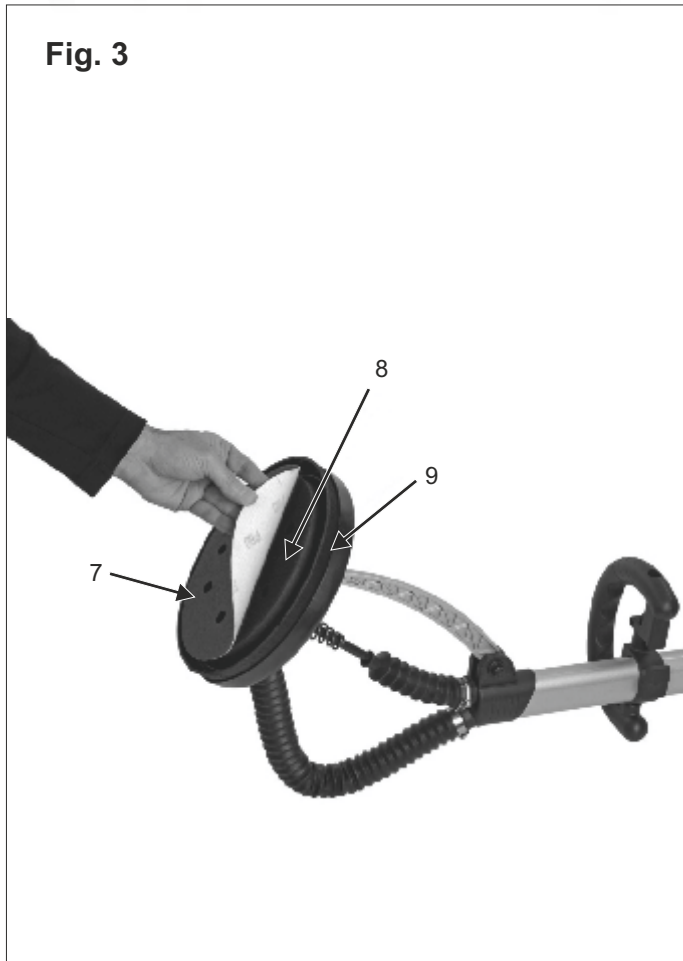
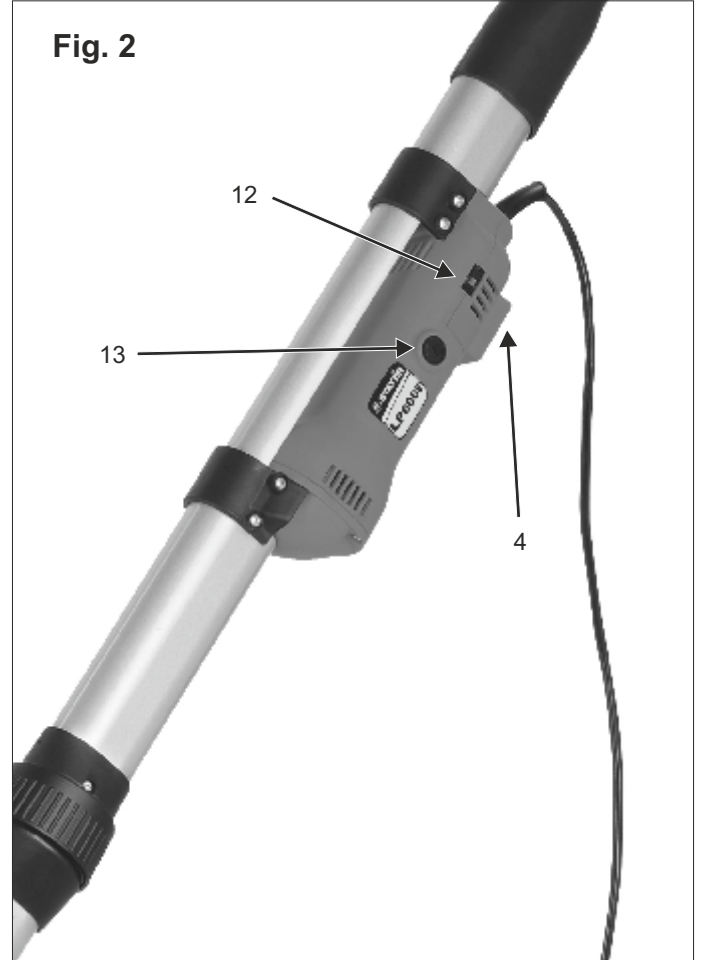
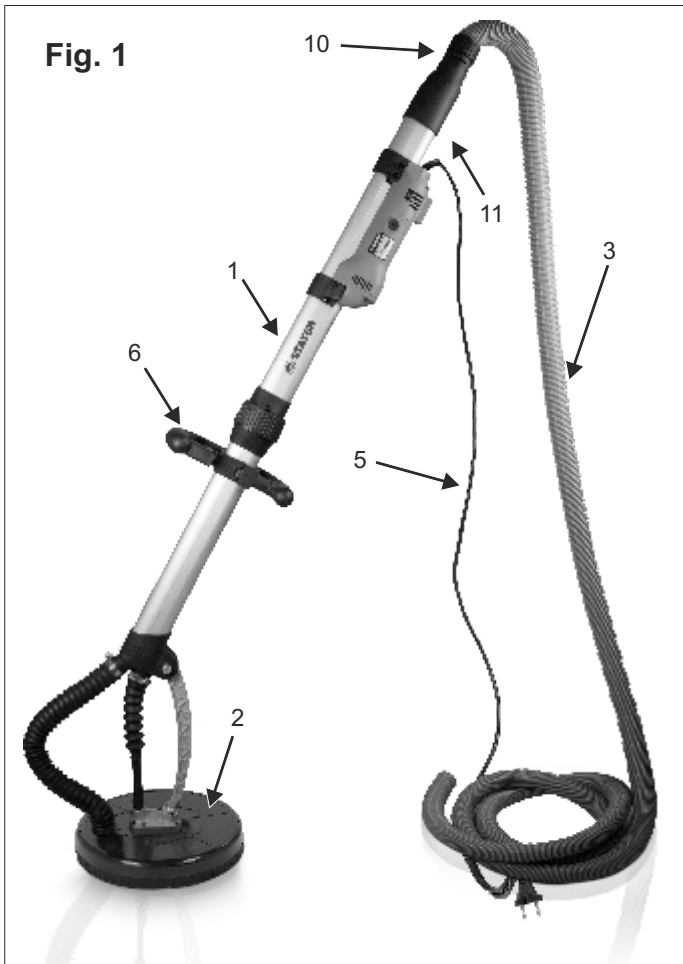

LP600 BE

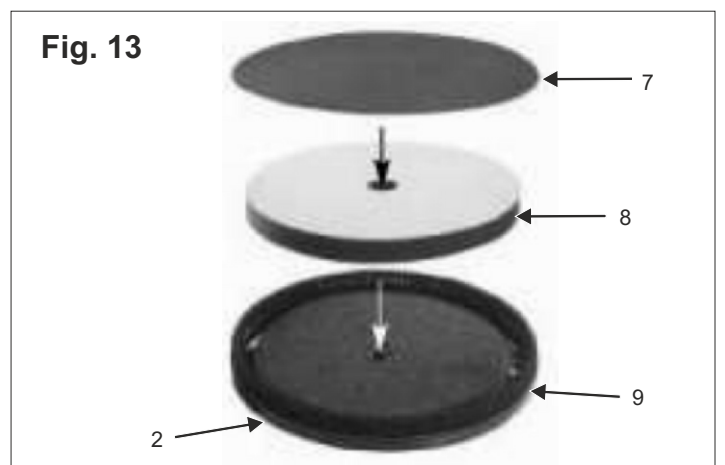
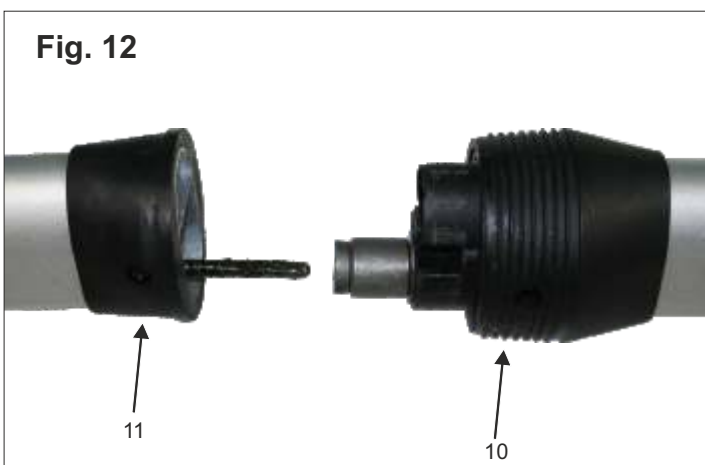
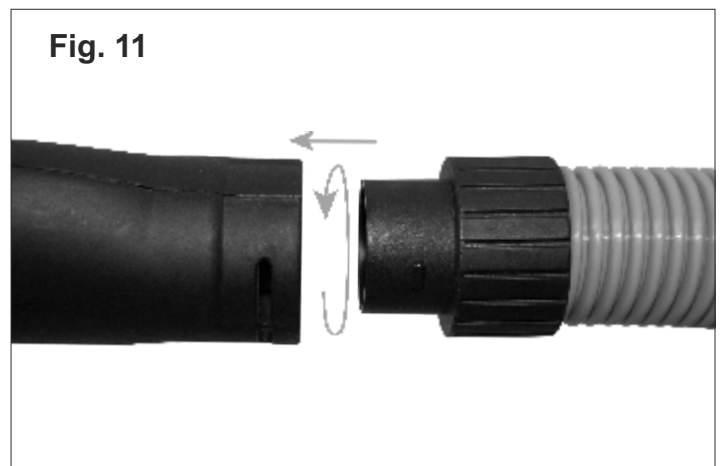
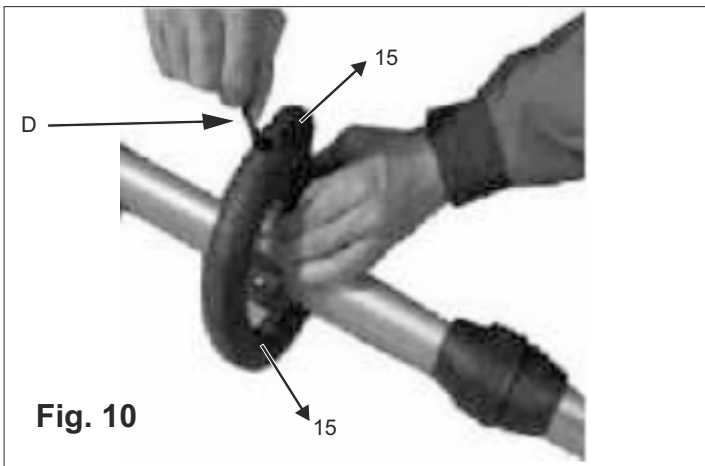
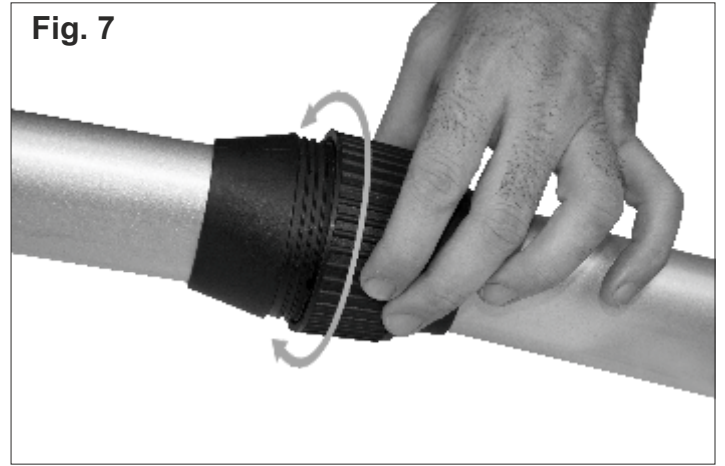
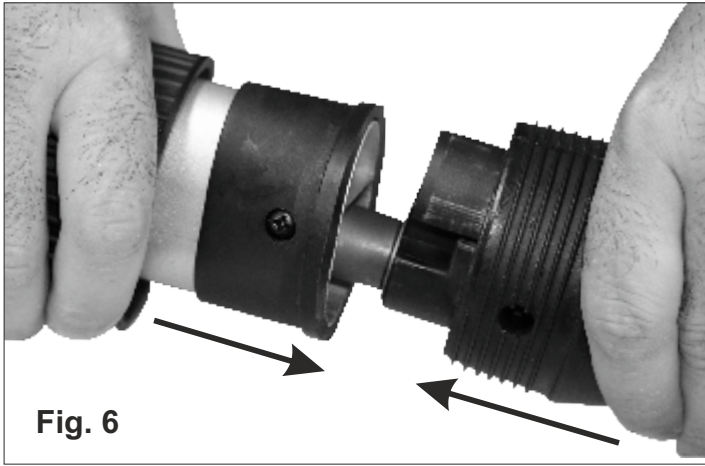

LP700 E

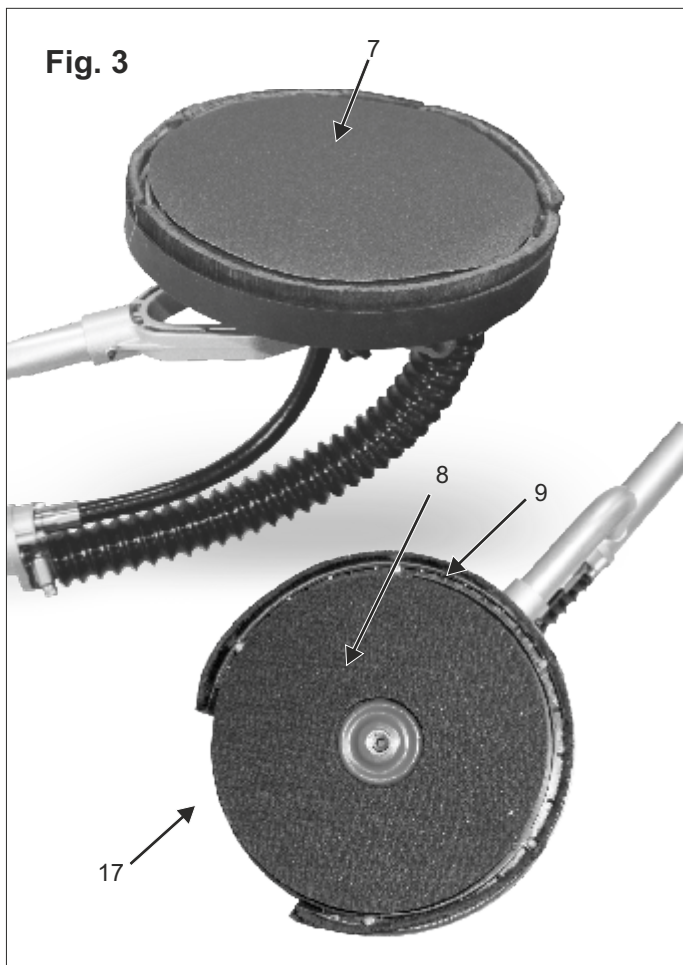
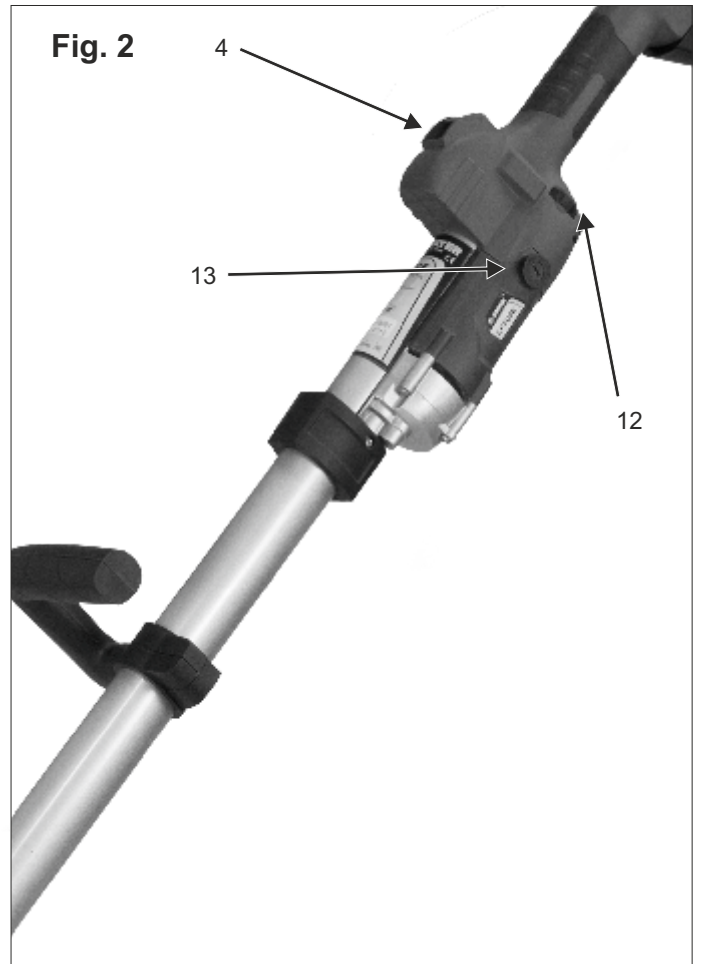
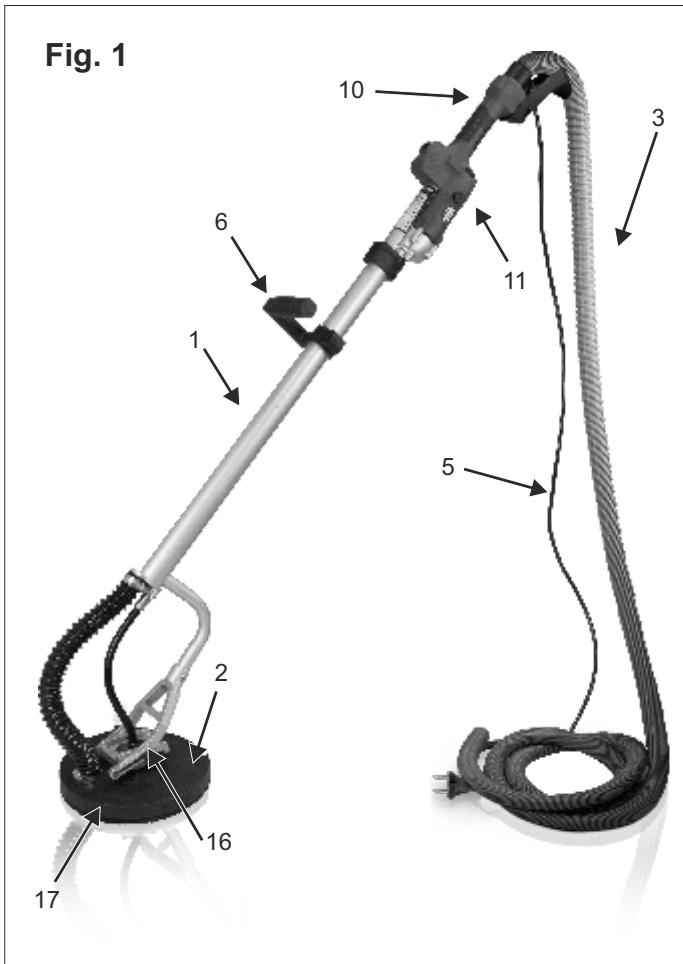

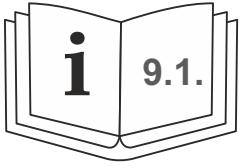

		LP600BE	LP700E
	W	620	710
	V	230	230
	min ⁻¹	1000 - 2000	800-1700
D_{max}	mm	225	225
	m	2,5	-
	m	4	4
	kg	4.5	4.3
	L _{pA} dB(A)	91	93
	L _{WA} dB(A)	102	103
	a _h m/s ²	2,8	2.9

EN60745, K = 3dB (L_{pA}, L_{WA}) K = 1,5 m/s² (a_h)

Thank you very much for acquiring a STAYER product!

The drywall sander is designed for sanding walls and ceiling that are made of drywall or plaster. The sander provides a superior finish, and is faster than conventional finishing methods for both new construction and renovation work. It is designed to work in conjunction with a vacuum cleaner for minimum dust and best sanding results. The pivoting sanding head allows excellent results with minimum time and effort.

This manual is consistent with the date of manufacture of your machine, you will find information on the technical data of the machine acquired manual check for updates of our machines on the website: www.grupostayer.com



To ensure appropriate operation and performance of your new LP600BE / LP700E and to safeguard your own safety, it is mandatory that you carefully read this instruction manual before using the Electric spray gun.



Take special care in observing all safety precautions! If you do not observe these precautions you may suffer severe injuries or even die!

PACKAGING



Your STAYER LP600BE / LP700E will be delivered to you in a protective cardboard box so as to avoid damages during transport.



Cardboard is a basic commodity and thus reusable and suitable for recycling (recycling of used paper).

1. CONTENT LIST

2. General safety

3. Specific safety instructions

4. Commissioning instructions

- 4.1. Placement
- 4.2. Assembly
- 4.3. Electrical connection

5. Description

6. Operating instructions

- 6.1. Operation
- 6.2. Position wall / ceiling (LP700E)
- 6.3. Tool change
- 6.4. Adjusting operation

7. Instructions of use

- 7.1. How to use the tool
- 7.2. Cleaning and maintenance
- 7.3. Elimination

8. Maintenance instructions

- 8.1. Cleaning, maintaining, lubricating, sharpening
- 8.2. Repair service

9. Legal regulations

- 9.1. Technical features
- 9.2. Guarantee
- 9.3. Declaration of conformity

2. GENERAL SAFETY



Read all safety warnings and all instructions. Failure to follow the warnings and instructions may result in electric shock, fire and/or serious injury.

3. SPECIFIC SAFETY INSTRUCTIONS

- Keep your hands away from rotating sanding head area at all times.
- Prolonged breathing of airborne dust from drywall sanding may effect respiratory function:
 - Always use a vacuum cleaner with a bag approved for drywall dust installed.
 - Always wear a respirator approved for dust and mist.
- Sanding lead-based paint is extremely toxic and should not be attempted. Only allow professionals with special training and equipment perform this task.
- Maintain proper footing and balance at all times. Do not overreach. Use proper scaffolding.
- Always wear appropriate safety equipment when operating.
- Important: after completing sanding, switch off the switch and wait for the coasting sanding head to stop completely before putting the tool down.
- Never operate the tool in an area with flammable solids, liquids, or gases. Sparks from the commutate I carbon brushes could cause a fire or explosion.
- There are certain applications for which this tool was designed. The manufacturer strongly recommends that this tool cannot be modified and I or used for any application other than for which it was designed.
- Use the machine with both hands at all times. Loss of control can cause personal injury.
- Keep power supply cord clear from the working range of the machine. Always lead the cable away behind YOU.
- Immediately switch off the machine if unusual vibrations or if other malfunctions occur. Check the machine in order to find out the cause.
- The dust that arises when working with this tool can be harmful to health. Use a dust absorption system and wear a suitable dust protection mask and remove deposited dust with a vacuum cleaner.

4. COMMISSIONING INSTRUCTIONS



WARNING: Read this manual and general safety instructions carefully before using the appliance, for your own safety. Your power tool should only be passed on together with these instructions.

4.1. Placement

Be sure to work in a clean, stable, and with possibilities of movement.

4.2. Assembly

Unpacking (Fig. 1)

Carefully remove the tool and all loose items from the shipping container.

Retain all packing materials until after you have inspected and satisfactorily operated the machine.

Assemble lower and upper tube part (Fig.5-6-7-8)

Tilt sanding head of lower part upwards to move propulsion (flexible shaft with square shaped end) out of the end of the ALU tube.

Pull out the drive shaft of the upper machine part (with motor) about 4-5 cm (avoid pulling it out of the gear box, in case you do, re install and pull out less).

Slide square shaped end into receiving end of upper part.

- Push lower and upper part together. (Fig.6)
- Fasten plastic tightening ring securely.(Fig.7)
- Now the both ends are mounted.(Fig.8)

Assemble auxiliary handle (Fig.11)

Put support around the tube at position of your choice

Insert fixation screw and tighten securely.

Now place handle (6) onto the support clip.

Please notice the notch on 1 side, to coincide with "the opposite notch on the support clip. (This notch prevents handle from unwanted turning).

Fix with hexagonal bolt M8 on both sides. Tighten with supplied hex key (Allan key).

The machine is now fully assembled and ready for use.

To install the vacuum cleaner hose (Fig.9-10)



Unplug the machine.

- Plug the vacuum cleaner hose bayonet mount (10) into the swivel mount (11) in the back of the machine. Once the tongs of the bayonet mount (clamps) (10) are fully inserted in the slots, hold the swivel mount (11) from turning and turn the hose bayonet mount (10) clockwise to lock.
- Removal is the opposite of assembly. Ensure that you have a bag installed in your vacuum cleaner which is approved and rated for drywall dust.
- Is recommended to use vacuum cleaner with automatic stirrer to prevent the filter clogging.

WARNING: Failure to use an approved dust bag in your vacuum cleaner will increase the level airborne dust in the work area. Prolonged exposure to such dust may cause respiratory harm.

4.3. Electrical connection

The network voltage must conform to the voltage indicated on the tool name plate. Under no circumstances should the tool be used when the power supply cable is damaged. A damaged cable must be replaced immediately by an authorized Customer Service Centre. Do not try to repair the damaged cable yourself. The use of damaged power cables can lead to an electric shock.

5. DESCRIPTION

1. Main tube
2. Sanding head cover
3. Vacuum hose
4. ON/OFF switch
5. Power supply cable
6. Auxiliary handle
7. Sanding paper

8. Velcro head Base
9. Head Brushes
10. Vacuum cleaner hose bayonet mount
11. Swivel mount
12. Speed adjusting wheel
13. Carbon brush cover
14. Based screw fastening the handle
15. Lateral grip screws
16. Selector wall / ceiling
17. Access edge (LP700E)

6. OPERATING INSTRUCTIONS

6.1. Operation

Starting and stopping tool

Make sure that the power circuit voltage is the same as that shown on the specification plate of the machine and that switch (4) is "OFF" before connecting the tool to the power circuit.

Switching the machine on and off

To switch ON:

Hold the left hand on the column and the right hand on the main handle. Now press the rocker switch to the "ON" position (4). Anticipate and be ready for the start up torque when the machine first starts.

To switch OFF:

Press the rocker switch to the "OFF" position (4). After the machine has been switched off, the sanding disc (7) will still rotate for a rime. Take care that parts of your body do not come into contact with the disc and do not set the machine down while it is still rotating!

6.2 Position wall / ceiling (LP700E)

Pull both ends of the selector (16) for moving the head (2) to the working position or ceiling wall.

6.3. Tool change

The brush bristles (9) on the edge of the sanding plate cover (2) serve two purposes, they keep the sanding disc (7) properly aligned with the work surface without gouging and they also help the efficiency of the dust collection by the vacuum cleaner. These brush bristles (9) will wear with continued use.

The sanding plate cover (2) should be replaced when the bristles (9) are too worn to ensure effective dust collection and stabilization of the sanding head.

To replace, hold the centre bolt from turning with a slot head screwdriver and unscrew the sanding plate. Then, using snapping pliers, remove the cir-clip which holds the sanding plate cover to the bracket. Remove the vacuum hose (3) and lift sanding plate cover away.

Replacement is the opposite of removal. Entrust all repairs to an authorized service centre.

NOTE: Only use sandpaper discs (7) which fit properly and which are designed for vacuum use.

The carbon brushes

The carbon brushes (13) are a normal wearing part and must be replaced when they reach their wear limit.

Unscrew the cap (13) with a coin or screwdriver. Always replace both worn brushes with a new pair.

NOTE: Checking and replacing the carbon brushes should be entrusted to a qualified service center.

The carbon brushes furnished will last approximately 50 hours of running time or 10.000 ON/OFF cycles. Replace both carbon brushes when either has less than 1/4" length of carbon remaining. To inspect or replace brushes, first unplug the machine and lay it on its left side. Unscrew the handle housings by removing the four screws. Remove the housing covers by removing the six screws. Remove the motor, while ensuring the first drive shaft, located in the column, remains attached to the secondary drive shaft.

Carbon brushes replacement:

- Unscrew the brush -holder caps using a cutting tool!
- Extract the worn brushes and replace them with new ones.
- Lock the brush-holder caps.

To replace the hook and loop sponge pad (8):

The sponge pad must be perfectly flat to get good sanding results. If it is deformed or damaged it will cause very uneven sanding. Always replace it when damaged. It is hook and loop on both sides, so to replace it, peel it away from the hook and loop on the Sanding Plate Base (8).

To install a sandpaper disc:

- Unplug the machine.
- Peel away the worn out sandpaper disc (7), leaving the sponge backing pad in place.
- Carefully press the new sandpaper disc into place. It will be held securely by the hook and loop backing.
- Make sure the sandpaper holes (7) and the support holes (8) match. This will help to optimal dust extraction.

6.4. Adjusting operation

Adjusting the rotation speed (Fig.9-10)

To adjust the height of the auxiliary handle 6, you must:

-Loosen the side screws of auxiliary handle 15 with the supplied key D.

Then loosen the screw securing the base of the handle 14, proceed to place the handle in the desired height.

-To lock the handle to the desired height, tighten the tontillo 14, place the hilt and screw 15 with the supplied allen key D

The speed of the machine is variable to suit different tasks. It can be adjusted from 1000 min⁻¹ up to 2000 min⁻¹ by using the thumb wheel (12). Turn in the counter clockwise direction to increase the speed and in the clockwise direction to decrease the speed. Generally, you should use the higher speed for fast stock removal and the lower speed for more precise control.

7. INSTRUCTIONS OF USE

7.1. How to use the tool

Effective control of this powerful tool requires two-handed maximum safety and control. The proper hold is to keep one hand on the main handle and the other hand on the sponge grip on the column. It is vitally important to keep stable footing at all times, especially when scaffolding or stilts.

- Once the machine and vacuum cleaner are set up and all safety measures and equipment are in place, begin by turning on the vacuum cleaner and then the machine. (If you are using a vacuum cleaner with integrated switching, then simply turn the machine on.)
- Begin sanding and carefully contact the work surface as lightly as possible-just enough to keep the sanding head flat against the surface.
- The joist in the sanding head allows the sanding disc (7) to follow the contours of the work surface.
- The best technique is to use overlapping sweeps and keep the head in constant motion. Never stop too long in any one place or there will be swirl marks. With experience it will be very easy to create excellent results.

NOTE: Ensure that the sandpaper (7) you are using is suited to the task, overly coarse grit paper may remove material too quickly to control. While overly fine grit paper may clog too often and not shape down the surface.

CAUTION: Take care to avoid sharp projections and nails, etc. This will wipe out the sandpaper and probably damage the sponge pad as well.

7.2. Cleaning and maintenance

Keep tool clean

Periodically blow out all air passages with dry compressed air. All plastic parts should be cleaned with a soft damp cloth. NEVER use solvents to clean plastic parts. They could possibly dissolve or otherwise damage the material.

Wear safety glasses while using compressed air.

Clean the vacuum swivel connector as too much dust will keep it from turning freely.

7.3. Elimination

We recommend that the power tools, accessories and packaging should be a recovery process that respects the environment.

Only for EU countries:

Do not dispose of power tools into household waste!

According to the European Directive 2002/96/EC on Waste Electrical and Electronic Equipment and its implementation into national law, must accumulate separately for power tools under an ecological recycling.

Subject to modification.

8. MAINTENANCE INSTRUCTIONS

8.1. Cleaning, maintaining, lubricating, sharpening

Before any work on the machine itself, pull the mains plug. For safe and proper working, always keep the machine and ventilation slots clean.

In extreme working conditions, conductive dust can accumulate in the interior of the machine when working with metal. The protective insulation of the machine can be degraded. The use of a stationary extraction system is recommended in such cases as well as frequently blowing out the ventilation slots and installing a residual current device (RCD).

Please store and handle the accessory(-ies) carefully. If the machine should fail despite the care taken in manufacturing and testing procedures, repair should be carried out by an after-sales service centre for **STAYER** power tools.

8.2. Repair service

The technical service will provide you advice regarding questions you may have on the repair and maintenance of your product as well as on spare parts. You may also obtain exploded views and information on spare parts on the internet under:

info@grupostayer.com

Our team of technical advisors will be glad to guide you regarding acquisition, application and adjustment of products and accessories.

9. LEGAL REGULATIONS

9.1. Technical features

The values given are valid for nominal voltages [U] 230/240 V ~ 50/60 Hz - 110/120 V ~ 60Hz. For lower voltage and models for specific countries, these values can vary. Please observe the article number on the type plate of your machine. The trade names of the individual machines may vary.

We reserve the right to change related to technical advance.

 = Power in watts

 = Rated voltage

 = Rotation speed

D_{max} = Disc diameter

 = Cable length

 = Flexible hose

 = Mass

 = Noise

L_{WA} = Acoustic power level

L_{pA} = Sound pressure level

 = Vibration

9.2. Guarantee

Guarantee card

Included in the documentation that accompanies this equipment, you should find the warranty card. You should fill out the card completely and return to vendor with a copy of purchasing receipt or invoice and you should receive a receipt.

Note: If you cannot find the warranty card within the documentation, you must ask for it through your supplier.

The warranty is limited only to manufacturing defects and expire if pieces have been removed or manipulated or repaired other than the manufacturer.

9.3. Declaration of conformity

The undersigned: **STAYER IBERICA, S.A.**

With address at:

Calle Sierra de Cazorla, 7
Área Empresarial Andalucía - Sector 1
28320 PINTO (MADRID)
Tel.: +34 91 691 86 30 / Fax: +34 91 691 86 31

CERTIFIES

That the machine:

Type: **DRYWALL SANDER**
Model: **LP600BE - LP700E**

We declare under our sole responsibility that this product is in conformity with the following standards or standardized documents:

UNE EN 60745-1:2010, UNE EN 60745-2-3:2007/A1:2010 according to EU Regulations 2006/95/CE, 2004/108/CE, 2006/42/CE

Ramiro de la Fuente
Director Manager



January 5, 2017



STAYER

Área Empresarial Andalucía - Sector I
Calle Sierra de Cazorla nº7
C.P: 28320 Pinto (Madrid) SPAIN
Email: sales@grupostayer.com
Email: info@grupostayer.com



www.grupostayer.com